

ES 2050 ES 2051

Electronic Controllers for water softening units

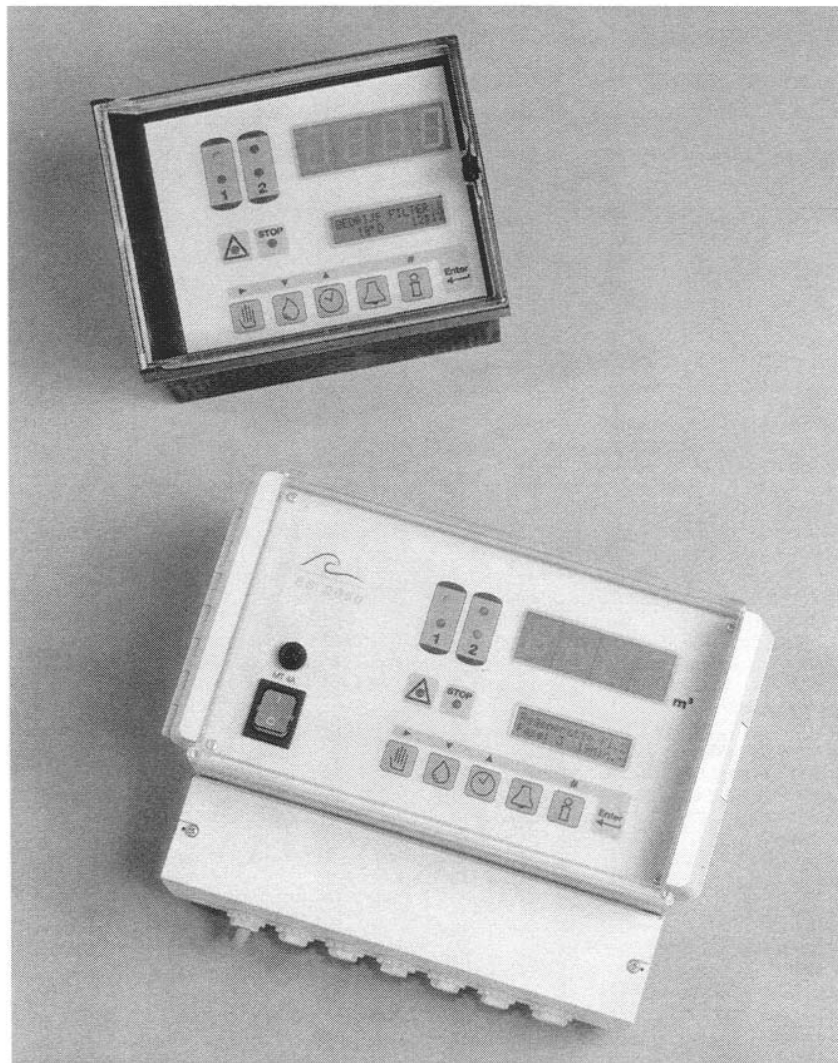

Instruction Manual

Software version 0002 3.00

CONTENTS

System Description.....	1
Wall mounted ES 2050, Panel mounted ES 2051.....	2
Status and Regeneration	
messages.....	3
LED - display.....	3
LED - control lamps.....	3
LCD - display.....	3
Service status.....	3
Regeneration status.....	4
Changing and indication of programme values.....	5
Hardness of the water supply.....	5
Current Time.....	6
Information DISPLAYS.....	6
Flush period.	6
Regeneration time.....	6
Regeneration restrictions.....	6
Additional program.....	7
Unit capacity.....	7
Treated water produced.....	7
Inputs.	8
Outputs.....	8
Service - Telephone number.....	8
Maintenance.....	8
Software version.....	8
Alarms / warnings.....	9
Programmed capacity exceeded.....	9
Electrical supply failure.....	10
Refill chemical tank.....	10
Await regeneration.....	11
Pre contact (regeneration pre initiation warning)	11
Minimum inter regeneration time limit.....	12
Minimum/maximum programmed value exceeded.....	12
Message: Maintenance.....	12
Manual regeneration initiation.....	13
Remote control.....	14
"water meter" Signal input.....	14
"chemicals low" Signal input.....	14
"await " Signal input.....	14
"start" Signal input.....	15
"duty changeover without regeneration" Signal input.....	15

Special functions.....	16
Duty changeover without regeneration.....	16
Regeneration of the standby unit.....	16
Regeneration stop.....	16
Fast program facility.....	17
Flush ON/OFF.....	17
Regeneration without counter Reset.....	17
Setting and changing of initial values.....	18
1. Duty changeover.....	19
2. Pre service regeneration.....	19
3. Prohibited regeneration period.....	20
Start on real time clock.....	21
4. Time controlled regeneration.....	22
5. Minimum time between regeneration's.....	23
6. Water meter.....	24
7. Flow-pulse.....	24
8. Incoming water supply hardness.....	25
9. Exchange capacity.....	26
10. Pre regeneration signalling.....	27
11. Number of valve switching pulses.....	28
12. Electrical control.....	28
13. Pulse timing.....	30
14. Regeneration times.....	31
15. Additional programme (Regeneration-additional programme, flushing, high pressure pump).....	32
16. Alarm and warning relay outputs.....	35
Capacity exceeded.....	35
Power supply failure.....	35
Refill chemical tank.....	36
Await regeneration.....	36
17. Input "WAIT".....	36
18. "Start" input.....	37
19. Service.....	37
Typical installation diagram.....	38
Remote monitoring control.....	38
Typical Electrical wiring diagrams.....	39
Electrical connection details.....	41
Installation recommendations and commissioning.....	42
Technical specifications.....	43
Declaration of conformity.....	44



System Description

The **ES 2050** (wall mounted) and **ES 2051** (panel mounted) controllers are designed for the monitoring and control of simplex (single exchange column) and duplex (twin exchange columns) water softener installations.

Whilst a simplex installation can not provide softened water to service when the exchange column is in regeneration, a duplex installation is capable of providing treated water from one column whilst the other is being regenerated. Duplex plants can be operated either in duty/standby mode (one unit in service, the other either in regeneration or waiting to be called into service), or in parallel mode (both units in service except when one is regenerating). The regeneration of an exchange column is effected either by one central control valve or by means of a pilot system controlling individual valves.

Regeneration is usually initiated after a measured volume of water has passed through the plant, this volume is automatically calculated when the exchange capacity and the feed water hardness are programmed into the controller. Alternatively the regeneration cycle may also be initiated either, after a predetermined time period, or, by the operation of an external contact e.g. hardness monitoring equipment, or, push button, or, based on the real time clock. Because, particularly with simplex plants, there can be periods of the day when regeneration would be undesirable, e.g. periods of high demand, the control can be programmed so that regeneration cannot take place between certain times. When this postponed regeneration facility is in use, any initiation signal is stored and a display indicates the earliest time at which the already initiated regeneration cycle may commence.

An external contact may be used to:

- a) inhibit or abort a regeneration cycle
- b) open or close the service valve.

In order to prevent microbiological degradation of the unit due to prolonged periods of non operation, the stand-by unit of a duplex water softener installation can be regenerated immediately prior to being put into service.

A minimum time interval between successive regeneration cycles may be set, thus allowing brine systems to recover between regeneration's, if necessary.

Five volt free relay contacts are available for control of valves, pumps, lamps, etc. or can be used for remote monitoring.

1. Additional programme relay (programmable):
 - a) available before, during or after part of the regeneration cycle.
 - b) can be used to open a dump valve flushing the plant to drain each time a pre-set volume of treated water has been produced.
 - c) allows control of a valve or pump during the regeneration or service.
2. Regeneration relay:
Contact available during the regeneration cycle.
3. Flow pulse relay (programmable):
 - a) repeats the contact of the water meter for remote monitoring of water use.
 - b) used to control the fill valve of the chemical tank.
4. Warning relay:
Programmable warning contact.
5. Alarm relay:
Programmable fault contact.

Wall mounted ES 2050

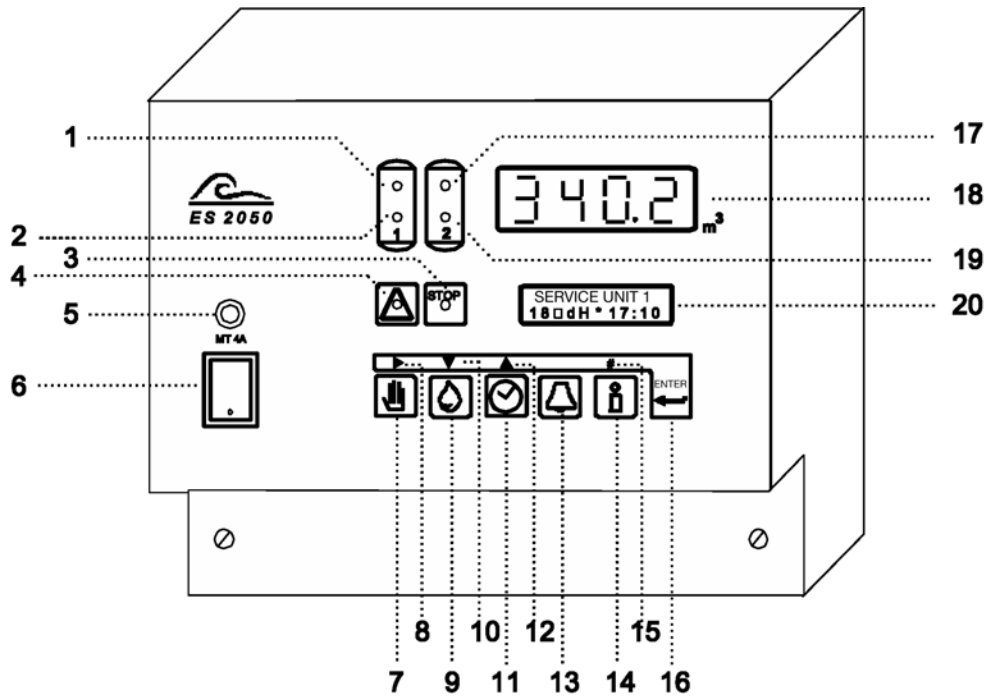

- | | | |
|----------------------|-------------------------|------------------------|
| 1 Service unit 1 | 8 Position cursor | 15 Numerical input |
| 2 Regeneration unit1 | 9 Supply water hardness | 16 Programming |
| 3 Alarms | 10 Next program | 17 service unit 2 |
| 4 Warnings | 11 Real Time | 18 LED Display |
| 5 Fuse | 12 Previous program | 19 Regeneration unit 2 |
| 6 Main switch | 13 Unlock | 20 LCD display |
| 7 Regeneration start | 14 Information | |

Panel mounted ES 2051

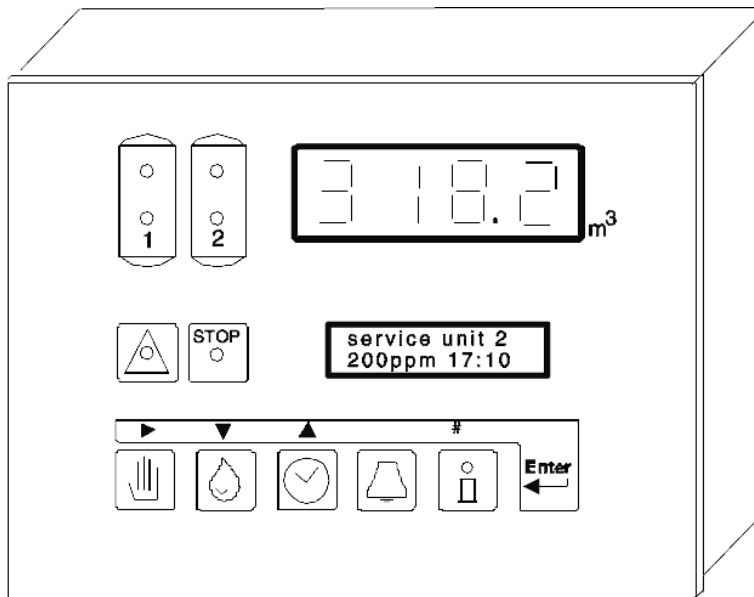

Status and Regeneration messages

LED - display.

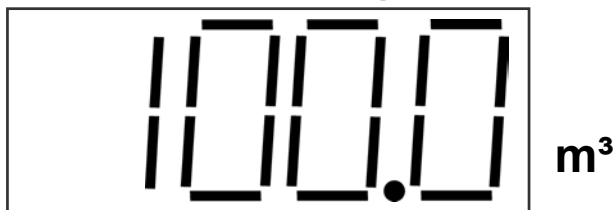

Whilst a unit is in service the LED - display indicates the remaining volume of water which can be softened before the next regeneration will be required.

When operating without a water meter, i.e. in time control, the display usually shows the full capacity between regeneration's.

During the regeneration of a simplex plant the display will read " 0 m³ ".

If the maximum value of 9999 is exceeded the LED display will show the text "OFL" as long as the value is to high.

NB! There is an additional "decimal point" in the bottom right hand corner of the display. This flashes when flushing has been commenced (see step 15 in the basic programme).

LED - control lamps

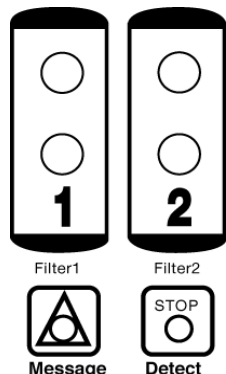

Coloured lamps are used to give the most important status indications.:-

- Unit 1 in service (green)
- Unit2 in service (green)
- Unit 1 in regeneration (yellow)
- Unit 2 in regeneration (yellow)
- Message (red)
- Fault (red)

Additional information is provided by the LCD display

LCD - display.

Service status.

The first line of the LCD display indicates the actual condition of the plant, e.g. unit 1 in service.

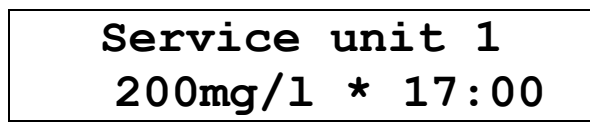

Usually during the service cycle the following information is given by the second line of the LCD:

- The left hand part of the line shows the incoming water hardness which has been programmed into the unit.
- In the central area the "*" symbol appears briefly to indicate that a pulse has been received from the water meter.
- The current time is displayed on the right.



However some operating regimes will produce alternative messages :-

Either:

<p style="text-align: center;">Service unit 1 Reg18:00 * 17:00</p>
--

- When operating with the control set to prohibit regeneration between certain times (section 3 of the programming instructions), if regeneration is required it will be postponed and the initiation signal stored until the end of the prohibited period, the second line of the display will show the time at which the unit will commence regeneration and the current time.

or:

<p style="text-align: center;">Service unit 1 Reg 72h * 17:00</p>

- If the control has been set to initiate a regeneration after a fixed time interval the second line of the display will show the number of hours remaining until regeneration will take place and the current time.

or:

<p style="text-align: center;">Service unit 1 Flush-time 20s</p>
--

- The control can be programmed to give a signal, e.g. for a bleed valve, each time a predetermined volume of water has been supplied. When this output is active the second line of the display shows the remaining signal duration.

Regeneration status.

The first line of the LCD display indicates the actual condition of the plant, e.g. unit 1 in regeneration.

<p style="text-align: center;">Regen. unit 1 Phase : 2 15 Min.-</p>

The second line of the LCD display shows, the regeneration step or phase in progress, the time remaining in the step and indicates, when an additional routine has been selected (section 15 of the programming instructions), whether the output is active. "-" indicates active "I" indicates inactive. If "Step: 0" is displayed it means that the additional routine will operate before regeneration can commence, similarly "Step: 6" indicates that the additional routine is continuing beyond the end of the regeneration cycle. If required the duration and remainder of the additional routine can be displayed briefly by pressing the INFO key (see page 6).



Changing and indication of programme values.

The most important programme values can be recalled and, changed if required, by pressing a key.

Hardness of the water supply.

Press the "Hardness" key, indicated by the symbol , to display the supply water hardness.

Water hardness:
220mg/l

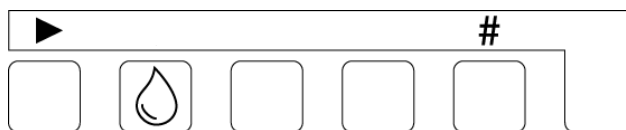

Should it be necessary to change the programmed value; the arrow key "▶" may be used to move the flashing cursor to the digit to be changed, and the Number key "#" to make the change.

A desired unit of hardness measurement may be selected (section 8 of the programming instructions), the following are available :-

Hardness units		Programmable range
°D	German hardness degrees	2 - 99
°F	French hardness degrees	4 - 199
°E	English hardness degrees	2 - 99
mg/l CaCO ₃	Milligrams per litre as CaCO ₃	40 - 1990
gpg	Grains per gallon	2 - 99

The controller automatically recalculates the capacity between regeneration's using the new value, at the initiation of the next regeneration cycle, as follows :-

$$\frac{\text{Column capacity [grms CaCO}_3 \text{ /m}^3 \text{ of resin x m}^3 \text{ of resin]}}{\text{Supply Water Hardness [mg/l ~ CaCO}_3\text{]}} = \text{Softened Water Capacity [m}^3\text{]}$$

If the resulting value exceeds the maximum value of the LED display (9999 m3) "maximum value exceeded" will appear in the display.

Important Note! If a hard water blending by pass is used so that the water meter indicates the blended water capacity, it is essential to subtract the final, blended, water hardness from the value to be inserted.

Example:

supply water hardness = 300 mg/l CaCO₃, blended water hardness = 120 mg/l CaCO₃

Thus a value of 180 mg/l CaCO₃ (300 mg/l CaCO₃ - 120 mg/l CaCO₃) must be programmed into the control.



Current Time.

Press the "Time" key indicated by the symbol , to display the current time.

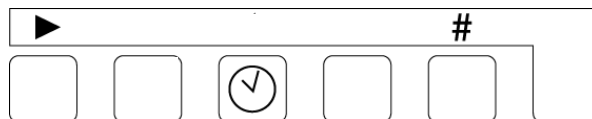
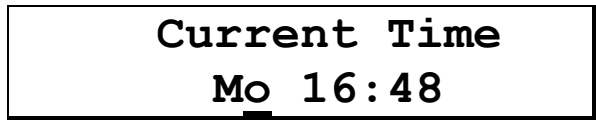

Should it be necessary to change the programmed value; the arrow key "▶" may be used to move the flashing cursor to the digit to be changed, and the Number key "#" to make the change.

Information DISPLAYS.

The "INFORMATION" key makes it possible to retrieve information, e.g. values from memory. Each time the "INFORMATION" key indicated by the symbol , is pressed a different piece of information is displayed :-

Flush period.

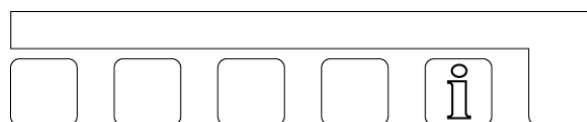
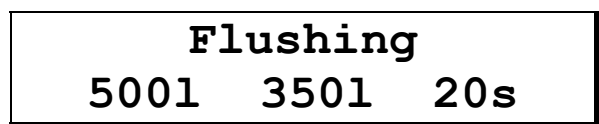

The programmed volume between successive flush signals, the volume remaining to the next flush signal and the duration of the flush signal are displayed.

Regeneration time .

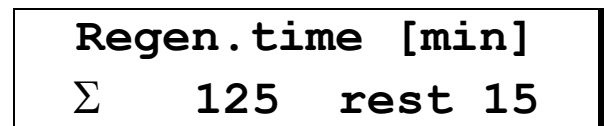

The duration of a complete regeneration cycle and the possible additional time which could be programmed in are displayed.

Regeneration restrictions.

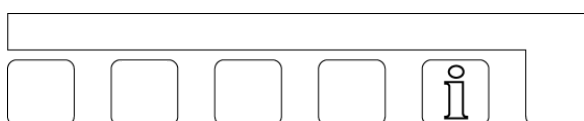
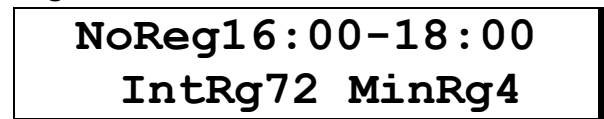

NoReg 16:00-18:00 if the control has been set to prohibit regeneration between certain times (section 3 of the programming instructions), this part of the display shows the time between which regeneration is prohibited. Otherwise the display will read : NoReg---.



IntRg 72 if the control has been set to initiate regeneration after a programmed time interval (section 4 of the programming instructions), this part of the display shows programmed time interval in hours. Otherwise the display will read : IntRg -.

MinRg 4 if the control has been set to give a minimum period between successive regeneration's (section 5 of the programming instructions), this part of the display shows the programmed time interval in hours. Otherwise the display will read : MinRg -.

Additional program.

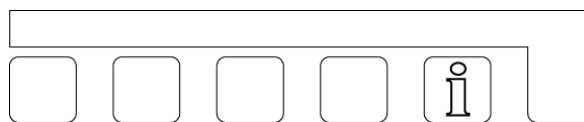
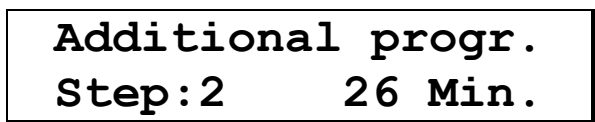

If the additional program has been selected (section 15 of the programming instructions), the selected start time and the duration of the additional program are displayed, if "Step 0" is displayed the additional routine will operate before regeneration can commence, similarly "Step: E" indicates that the additional routine will continue beyond the end of the regeneration cycle. If the program is activated the display shows how long it has left to run.

If no additional program in has been entered "No additional program" will appear in the display.

Unit capacity.

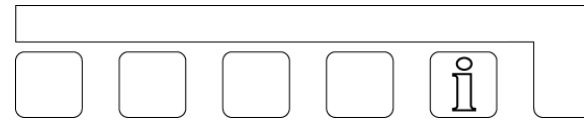
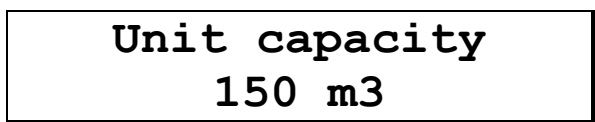

The calculated capacity between regeneration's is displayed.

Treated water produced.

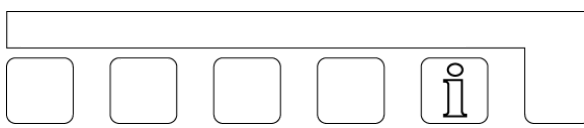
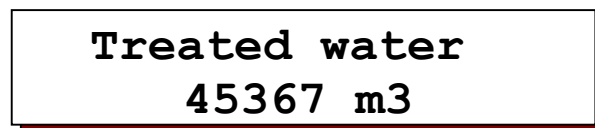

The total volume of water which has been treated by the plant.

Warning: This counter can be reset to zero by a service engineer, consult service logs for details of the value prior to reset.

Inputs.

Input
WM0 RC0 WA0 RS0

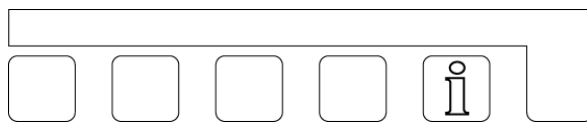

Indicates the current status of each input, the inputs are :-

WM = water meter RC = regeneration chemicals WA = wait RS = regeneration start

Inputs WM, WA, and RS are shown as active when the external contacts are closed, RC is active when the external contact is open. Active states are indicated by "1" after the input reference, inactive by "0".

Outputs.

Out123456789AB
 |-----

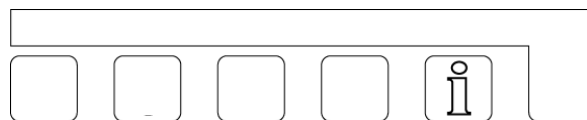

Indicates the current status of each output, " | " below an output number indicates an active output, " - " an inactive one.

Service - Telephone number.

Service
0031 73 443755

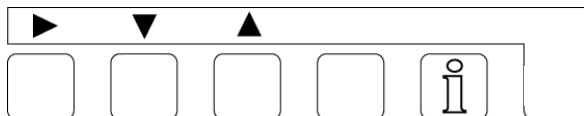

To change the telephone number.

Select the digit using the " ▶ " key, the number can then be changed by using either the " ▼ " or " ▲ " key.

Maintenance.

Maintenance
500m3 20m3

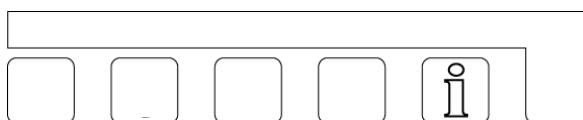

If the automatic maintenance required warning is programmed the pre set maintenance interval is displayed on left hand side of the second line and the quantity of treated water produced since the last maintenance visit is displayed on the right hand side of the second line.

Software version

Software-version
ES2050 9606-2.20

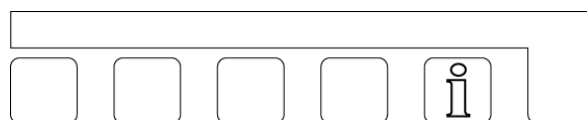

The software is regularly updated in the factory.

Modifications are made in order to adapt the product in accordance technological changes and customer requests. The display indicates which version of the software is loaded.

Alarms / warnings.

When the equipment is operating, various messages may appear in the display, this facility can be used to drive relay outputs or to give alarms or warnings. The relay positions are indicated by red control lamps bearing symbols for "Attention" for messages and "Stop" for alarms. The programming of these functions is described in sections 5, 10,15 and 18 of the programming instructions.

Descriptive text appears in the LCD display, in addition to the fault or warning light indication.

Programmed capacity exceeded.

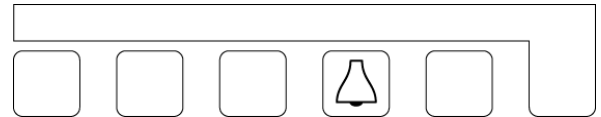

This message can only be displayed when controlling a duplex plant and appears if the working unit requires regeneration whilst the off line unit is in regeneration.

Possible causes when the plant is water meter controlled:

- Wrongly programmed capacity.
- Wrongly programmed incoming hardness.
- The water meter is faulty or of the incorrect type.
- Excessive demand for water e.g.. a large tank being filled very rapidly.

Possible causes when regeneration is remotely initiated by water analysis equipment signal:

- Faulty analytical equipment.
- Incorrect operation of analysis unit.
- Water analysis equipment too sensitive or giving spurious readings.
- Inadequate regeneration of the unit leading to shortfall in capacity.

IMPORTANT! In this condition if regeneration initiation is volume dependent, i.e.. by water meter, the on-line unit will begin to regenerate as soon as the other unit has finished it's regeneration.

If a salt saturator is being used and there is insufficient brine available for the second regeneration the second regeneration cycle must be prevented either by switching off the control or by giving a "wait" input. Once sufficient brine is available the second unit can be allowed to regenerate.

Press the "UNLOCK" key indicated by the symbol , in order to reset the warning or alarm relay. If the key is pressed a second time, the LCD display will also be reset, providing that the initiation signal is also no longer present. Then the regeneration of the second unit will not take place.

Electrical supply failure.

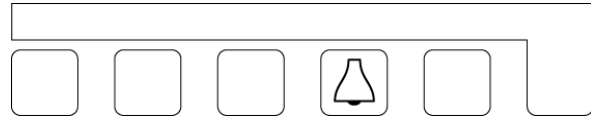

If there is a failure of the power supply no status information will be lost. The control panel "remembers" the condition it was in when the supply is interrupted.

NB. The current time will be lost and must be re-entered.

IMPORTANT! If the plant is in a regeneration cycle when the power supply fails it is possible for the unit to become partially exhausted, by the passage of water to drain, if the water supply is maintained during the power failure.

In this situation the regeneration cycle should be terminated and a new cycle initiated first ensuring sufficient chemicals are available.

Press the "UNLOCK" key indicated by the symbol , in order to reset the warning or alarm relay and then reset the current time.

Refill chemical tank.

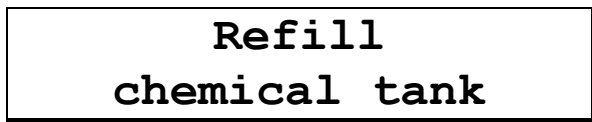

NOTE: This message can only appear only if there is a "regeneration chemicals" input connected.

Chemicals should be added to the chemical tank.

IMPORTANT! One regeneration cycle will be performed after this message appears. and regeneration may still be initiated by pressing the "REGENERATION START" key indicated by the symbol .

Press the "UNLOCK" key indicated by the symbol , in order to reset the warning or alarm relay. The message will then clear when regeneration chemicals are available.

With duplex plant operating in standby mode the standby unit will automatically be brought into service even though regeneration of the exhausted column cannot take place.



Await regeneration.



This message appears during the regeneration cycle only if there is a "Wait" contact, for example a water pressure switch intended to prevent regeneration when there is insufficient water pressure, connected.

Press the "UNLOCK" key indicated by the symbol , in order to reset the warning or alarm relay. This will abort any regeneration cycle which is in progress.

Important Note: If the manual regeneration key indicated by the symbol , is pressed the "Wait" signal is temporarily neutralised and the regeneration cycle will take place.

The alarm and warning relays and the LCD signals are cleared, as soon as the "wait" signal is removed. In order to prevent cancellation of the warning before the fault has been cleared it is not possible to manually reset the message relay.

With duplex installations, operating in standby mode, the stand by unit will be brought on-line if there is a "wait" signal when a regeneration cycle is initiated.

IMPORTANT If "EURO" is selected at step 12.4 of the programming sequence the outlet (pilot) solenoid valves will be closed in the service condition.

IMPORTANT Any additional programme (see page 31) will be disabled.

Pre contact (regeneration pre initiation warning).



This message will only be appear, if selected (section 10 of the programming instructions).

Press the "UNLOCK" key indicated by the symbol , in order to reset the display and the alarm relay, if programmed. If the warning relay is programmed it cannot be cancelled manually. This is to prevent premature disconnection of, for example, water analysis equipment.

The display and the relay are automatically cancelled when the regeneration cycle is initiated.



Minimum inter regeneration time limit.

Minimum regeneration period

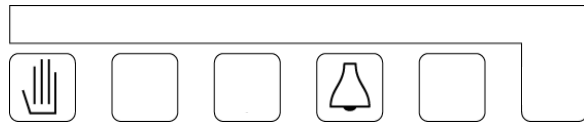

This message will only appear if a minimum interval between regeneration's has been programmed (section 5 of the programming instructions).

Possible causes when the plant is controlled by a water meter:

Wrongly programmed capacity.

Wrongly programmed incoming water hardness.

The water meter is faulty or of the incorrect type.

Excessive demand for water e.g. a large tank being filled rapidly.

Possible causes when activated by an external water analysis equipment signal:

Poor water quality from a column which has been on standby for some time, due to the contra ion effect. this can be overcome by fitting a flushing valve or circulation pump in the system or by reducing the sensitivity of the analytical equipment.

IMPORTANT Regeneration is not initiated. This must be done manually, this prevents repeated regeneration's due to a malfunction.

Press the "UNLOCK" key indicated by the symbol , to restore the display and reset the alarm relay, if programmed.

Maximum programmed value exceeded.

Max display value exceeded

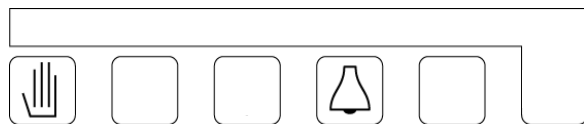

This indicates that the result of the automatic calculation exchange capacity / hardness lies outside the permissible range (0.1 - 9999). (Section 9 of the programming instructions)

Message: Maintenance.

Maintenance
0031 73 443755

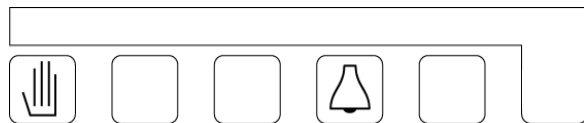

This message can only appear when the facility for giving an automatic warning that maintenance is due has been selected in section 18 of the programming sequence.

Press the "Reset" key with the  symbol in order to reset the alarm relay, if programmed, and call your maintenance company. The LCD display can only be cleared by trained personnel.



Manual regeneration initiation.

A regeneration may be manually initiated at any time. Press the "REGENERATION INITIATION" key indicated by the symbol , after 2 seconds regeneration of the on line unit is initiated.

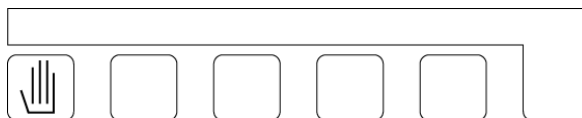

- With duplex installations operating in standby mode the stand by unit is brought into service.
- If manual initiation is attempted during a period in which the controller has been programmed to prohibit regeneration (section 3.1 of the programming instructions) the time at which regeneration will be initiated will appear with the current time in the LCD display. In a duplex plant, operating in standby mode, the stand by unit is brought into service.
- If the prohibited time function is already activated the regeneration will initiate, i.e. the prohibited time function will be overridden.
- The counter is reset to the calculated capacity after the regeneration.
- If the unit has been set to initiate a regeneration after a fixed time has elapsed, (section 4.1 of the programming instructions) the interval timer is reset to its programmed value and restarted.
- If a minimum time between regeneration's has been programmed (section 5.1 of the programming instructions), the timer will be overridden and reset.



Remote control.

The following functions may be remotely controlled by switch contacts connected to the terminal strip of the controller :-

"water meter" Signal input.

"Contact head"/"reed" water meters give a pulse each time a fixed volume of water has registered e.g. of every 100 litres. These pulses are counted by the controller and once the calculated capacity has been supplied a regeneration is initiated.

The controller cannot accept more than 5 pulses per second.

Receipt of a water meter pulse is indicated by the "*" symbol in the second row of the LCD display. (See page 3.)

"Chemicals low" Signal input.

This input signal can be used to monitor the chemical tank and prevent regeneration if there are insufficient chemicals available.

The warning will not immediately prevent a regeneration, because it is assumed that there will be sufficient chemicals present for one regeneration. By pushing the key "REGENERATION INITIATION" indicated by the symbol , it will be possible to override the warning and initiate a regeneration.

IMPORTANT! The input signal facility does not monitor the chemical tank until 3 hours after a regeneration has taken place, however if a regeneration is initiated during this time the chemical tank is checked. The facility is disabled during regeneration.

"await " Signal input.

This input can be used for either of two different functions (see section 17 of the programming sequence).

Either: Active during the regeneration

The input signal can be used to hold off or stop a regeneration cycle. The input is active only during a regeneration cycle.

With duplex installations, when the signal is active, regeneration of an exhausted unit can not be initiated but, if the plant is operated in standby mode, the standby unit will be brought on line.

After the "WAIT" signal is cleared the regeneration cycle is commenced or continued.



When "REGENERATION INITIATION" indicated by the symbol , is pressed, the "WAIT" signal will be suspended for the duration of the regeneration cycle.

When using the fast program key facility, (see special functions page 16) it is possible to step forward to the next regeneration step.

IMPORTANT If "EURO" is selected at step 12.4 of the programming sequence the outlet (pilot) solenoid valves will be closed in the service condition.

IMPORTANT Any additional programme (see page 31) will be disabled.

Or: Active during service.

The service valves will open or close in response to the input.

APPLICATION: Treated water storage tank level control.

"start" Signal input.

This input signal can be used to initiate a regeneration of the plant by remote means, e.g. a push button, or water monitoring equipment. When operating a duplex plant in standby mode the standby unit will be brought on line. A start-up delay can be set at program step 18.2

If remote initiation is attempted during a period in which the controller has been programmed to prohibit regeneration (section 3.1 of the programming instructions) the time at which regeneration will be initiated will appear with the current time in the LCD display. In a duplex plant, operating in standby mode, the stand by unit is brought into service. Regeneration is not initiated.

If a minimum interval between regeneration's has been programmed (section 5 of the programming instructions) if an attempt is made to initiate a regeneration during this interval the "minimum regeneration time" warning will be displayed. Regeneration will not be initiated, manual initiation will be required and the alarm must be manually reset. (see page 12.)

On a simplex plant the input is disabled during regeneration and only becomes available again once the regeneration is complete and the time entered at program step 18.1 has elapsed.

In double filter systems the input is blocked after the start of regeneration for the time entered at program step 18.1. Then if a start signal is present the report "system overloaded" is shown, since evidently both filters are exhausted.

NOTE The time entered at program step 18.1 is also activated after a power loss to allow for a measuring device to take a new measurement.

NOTE If the controller was programmed for de carbonisation (see text of program step 7), the blockage times referred to above do not apply. Instead the time from program step 18.1 is activated as a start-up delay for the first sampling in accordance with the time from program step 18.2. It is assumed that there is a measurement device which shows water quality directly (pH measurement).

“duty changeover without regeneration” Signal input.

If both the "Regeneration Chemicals" and the "Wait" input are activated (36-37 open and 38-39 closed) within a period of 1 second the plant will perform the "Duty changeover without regeneration" function. Once the plant has changed over the contact between 36 and 37 must be restored.

IMPORTANT If this facility is used Step 16.8 and 16.12 of the program must be set to "N".

Special functions.

These functions should only be used by a trained specialist, ill considered use of these functions will cause operating problems.

Duty changeover without regeneration.

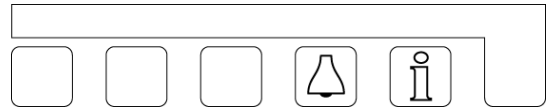



Press the "UNLOCK" key  and the "INFORMATION" key  simultaneously. On a duplex plant duty changeover takes place after 2 seconds delay.

IMPORTANT There are separate counters for each exchange column. If an almost exhausted column is brought into service, then that unit may require regeneration whilst the other unit is in regeneration. The "period capacity exceeded" warning will be displayed.

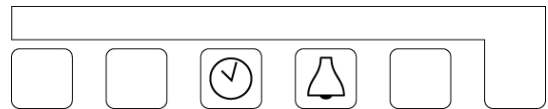

Regeneration of the standby unit.



Press the "TIME" key  simultaneously with the "UNLOCK" key . On a duplex plant regeneration of the stand by unit is initiated after 2 seconds delay.

Regeneration stop.



Press the "REGENERATION INITIATION" key  and the "UNLOCK" key  simultaneously. The regeneration in progress will be aborted after 2 seconds and the plant will be return to the normal service condition.



IMPORTANT Pilot stagers for manifold valves may not have an automatic "return to service" facility when the control is returned to the service condition, this type of stager will hold the plant in regeneration mode and will no longer be synchronised with the controller.

IMPORTANT If chemical has been drawn into the plant it will be necessary to rinse the chemicals out before allowing the plant to supply water to service.

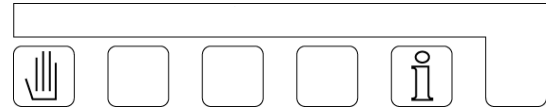

Fast program facility.



Press the "REGENERATION INITIATION" key  and the "INFORMATION" key  simultaneously, after 2 seconds delay the internal timer switches from minutes to seconds for the remainder of the current program step, at the end of the current step the timer returns to normal, the next regeneration step proceeds normally.

IMPORTANT When cycling through regeneration steps, sufficient time must be allowed between steps to permit the regeneration control valve to synchronise with the controller.

IMPORTANT If chemical has been drawn into the plant it will be necessary to rinse the chemicals out before allowing the plant to supply water to service.

Flush ON/OFF.





Press the "Unlock" key , and the "ENTER" key simultaneously.

After 2 seconds delay the flush will commence. If the flush is already in operation, using this key combination will end the flush period.

Regeneration without counter reset.



For maintenance purposes, it is possible to initiate a regeneration which will not reset the counter or recalculate the operating capacity.

Press the "HARDNESS" key  simultaneously with "UNLOCK" key .

With simplex installations regeneration is initiated without resetting the counter and without recalculation of the unit capacity.

With duplex installations regeneration of the stand by unit is initiated. If regeneration of the duty unit is required first initiate duty changeover as described above (see "**Duty changeover without regeneration initiation**"). The "**Regeneration stop**" and "**Fast program**" facilities are both available, in this regeneration cycle.

IMPORTANT If chemical has been drawn into the plant it will be necessary to rinse the chemicals out before allowing the plant to supply water to service.



Setting and changing of initial values.

During the commissioning of a water softener the basic parameters for the installation must be programmed into the controller. These values can be modified later but they will not be corrupted or lost by an electrical supply failure.

- Changes to the basic values should only be made by trained personnel.
- Note the basic values in the spaces provided in the programming diagram and keep this handbook in a safe place for use by service and maintenance personnel.
- A change to the basic values is possible at any time. The majority of the changes however only take effect after initiation of the next regeneration cycle.
- A number of keys have dual functions.

1. Press the "ENTER" key. In order to overwrite the existing program this key must be held down for 4 seconds, then the basic values are ready for modification.

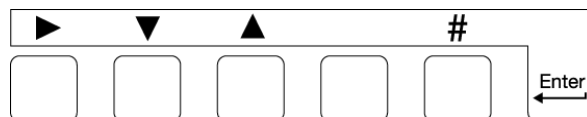

The following message appears in the LCD



the following message appears four seconds later



NOTE For steps 2 and 3 the "ENTER" key must be held down.

2. To change the **language in the LCD** display hold the "#" key down and use the "▶" key to move the cursor to the symbol of the country with the desired language.
3. The first and succeeding steps of programming can be entered by pressing the "▼" key.
4. With the "▲" key it is possible to return to the preceding step.

Note: The controller is still in the program mode. Do not keep the "ENTER" key pressed down any longer. To cease programming press the "ENTER" key at any time. The programming mode will be abandoned automatically if no key is pressed for approximately two minutes.

5. With the "▶" key it is possible to move the cursor, YES/NO choices can be made affirmative by moving the cursor to the Y key, and negative by moving it to the N key.
6. To modify numeric values move the cursor to the digit to be modified and then use the "#" key to change the value.

IMPORTANT

Once a regeneration cycle has commenced all programmable functions except the duration of each regeneration step (section 14 on the programming instructions) are locked until the cycle is complete.

1. Duty changeover.

Step nr:	1.1
Single unit	Y/N

A simplex installation (consists of only) one unit. Connections for number 2 unit are unused.

Step nr:	1.2
2-tank alter.	Y/N

A duplex installation usually works in standby mode (one unit gives treated water, the other one is in regeneration or in standby).

Step nr:	1.3
Parallel serv	Y/N

If a large flow of treated water is required it is possible for a duplex plant to work in parallel. When not in regeneration the plant is able to provide treated water from both columns.

Step nr:	1.4
valve 9000	Y/N

This program is intended solely for a Fleck 9000 central control valve.

ATTENTION When using this valve, the instructions vary in a number of details. Pay close attention to the additional instructions on the special insert-sheet relating to this valve.

2. Pre service regeneration.

Step nr:	2.0
Pre regen.	Y/N

If the treated water is used for drinking purposes then it is important to prevent bacterial growth. A stand by unit could possibly cause contamination due to bacterial growth during a long period off line. Regeneration can be programmed to take place immediately prior to the unit coming into service. Regeneration is held in abeyance until the duty unit is "exhausted".

Important The additional water which will be supplied at the end of the duty period must be allowed for in setting the operating capacity if this facility is used.

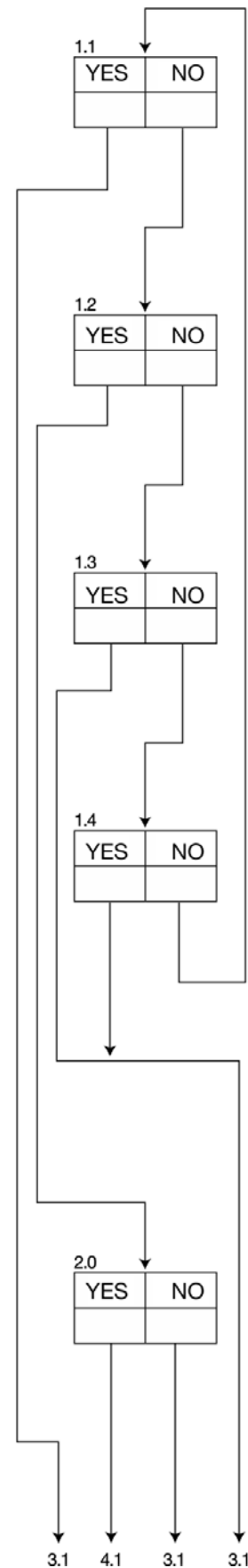

3. Prohibited regeneration period.

Step nr:	3.1
Time Delayed	Y/N

A regeneration may be started at any time of the day but, for operational reasons, there may be times when regeneration would be undesirable e.g. the water pressure may be too low or demand may be high. In standby duplex mode, the standby unit will be brought into service and the exhausted unit will regenerate at the end of the prohibited period.

Mo	Tu	We	Th	Fr	Sa	Su
-	-	-	-	-	-	-

Select the day when the function “prohibited regeneration period” function must be active. “-“ = not activated, “|” = activated

Step no:	3.3
Start time	6:30

Enter the time at which the prohibited period commences.

Step no:	3.4
Stop time	18:30

Enter the time at which the prohibited period ends.

Step no:	3.5
Main valve on	Y/N

For a simplex installation, it is possible to choose whether the outlet/supply valve (SV) remains open until regeneration starts or is closed immediately.

If the outlet valve remains open, it is important to ensure that the exchange column is able to deliver treated water if the regeneration warning is given before the column is exhausted, (see programming steps 10.1 – 10.3).

If the outlet valve is closed immediately provision must be made for the lack Of water or a reservoir of treated water must be provided sufficient for the prohibited period and the regeneration period

With a duplex plant operating in parallel then a decision must be made whether the outlet valve for the exhausted column should remain open until the start of the regeneration or should close leaving only one unit in service.

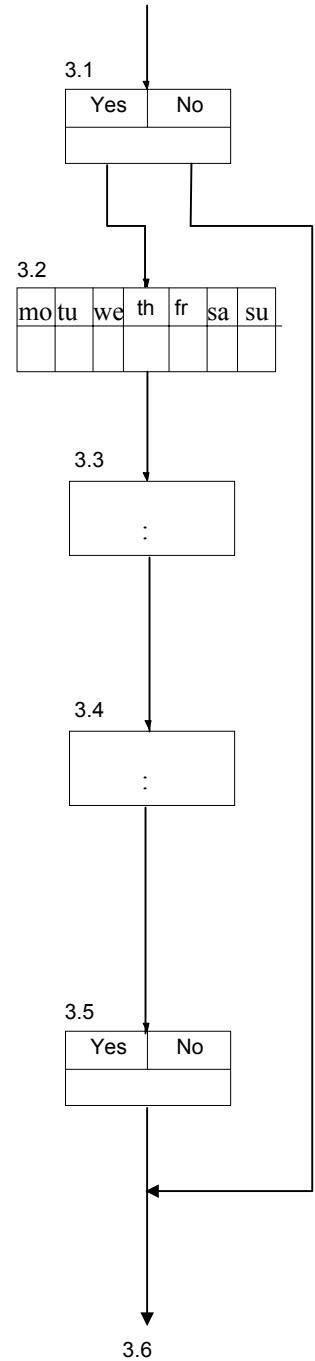



3. Starting on real time clock

Step no.:	3.6
Time start	Y/N

A regeneration can be started depending of the real time clock.
 There is the possibility for programming two starting times at one day

Mo	Tu	We	Th	Fr	Sa	Su
-	-	-	-	-	-	-

Select the day(s) for starting regeneration of the unit in service at the time programmed in step 3.8. "-" = not activated, "|" = activated

Step no.:	3.8
Start time	00:30

Enter the time at which the unit in service will go into regeneration.

Mo	Tu	We	Th	Fr	Sa	Su
-	-	-	-	-	-	-

Select the day(s) for starting regeneration of the unit in service at the time programmed in step 3.10. "-" = not activated, "|" = activated

Step no.:	3.10
Start time	05:30

Enter the time at which the unit in service will go into regeneration.

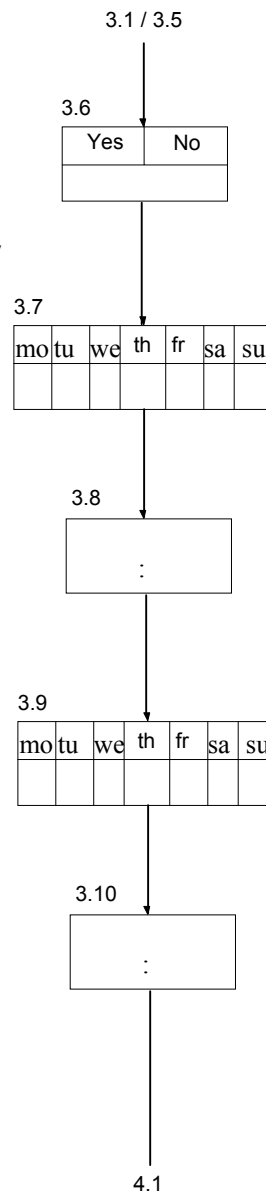



4. Time controlled regeneration

Step nr:	4.1
Interim start	Y/N

Regeneration can be initiated at fixed time intervals. This operating mode is selected if a water meter is not desired either because the water usage is regular and predictable or for operational reasons.

Sometimes this mode of operation is selected where there is a danger of micro organism formation within the unit due to a prolonged standby period. The facility is used to override volume dependant or quality dependant initiation.

At each time controlled regeneration, the water meter counter is reset.

Step nr:	4.2
Period	72h

A time period of between 1 to 999 hours between regeneration's may be programmed.

IMPORTANT! With installations utilising brine tanks it may be necessary to await the availability of full strength brine, the actual time will depend upon the type of brine system used but could exceed 4 hours.

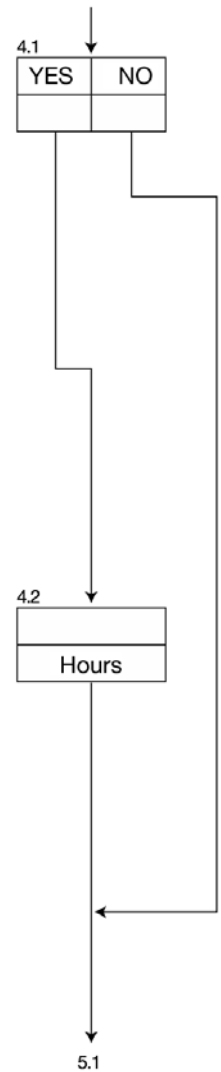

5. Minimum time between regeneration's.

Step nr:	5.1
Min.reg.time	Y/N

Based on the capacity of the installation, the incoming water hardness and flow rate, the minimum time between two regeneration cycles can be calculated.

With installations utilising brine tanks it may be necessary to allow time for full strength brine to be produced, the actual time will depend upon the type of brine system used but could exceed 4 hours.

When there are very large requirements of water, for instance when filling a large tank, if this minimum time requirement is not taken into account and the plant may be insufficiently regenerated because of unsaturated brine.

If a water softener installation is also equipped with water hardness monitoring equipment, the minimum time period between regeneration's must be programmed. Otherwise, should there be a defect e.g. with the monitoring equipment the unit will continuously regenerate.

Step nr:	5.2
Period	4h

The minimum time between two regeneration's can be anything between 1 and 999 hours.

Step nr:	5.3
Alarm	Y/N

If a regeneration cycle is initiated before the programmed time has been reached then a warning is shown in the LCD display. The warning relay can also be activated if desired.

Step nr:	5.4
Warning	Y/N

If a regeneration cycle is initiated before the programmed time has been reached then an alarm is shown in the LCD display. The alarm relay can also be activated if desired.

See also: Minimum inter regeneration time limit, page 12

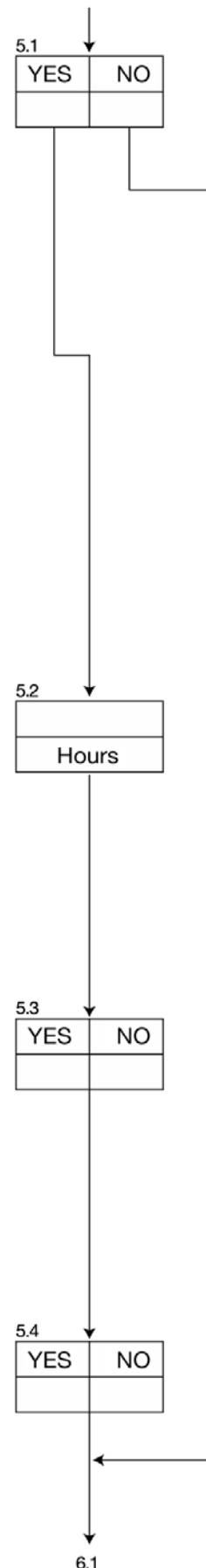

6. Water meter

Step nr:	6.1
Watermeter	Y/N

Using a contact head/reed water meter, the volume of treated water produced is measured and, when the pre-programmed quantity of water has

been supplied, regeneration is initiated.

The LED display usually shows the capacity remaining i.e. the amount of water which can be treated before regeneration is required.

NOTE: If no water meter is used (e.g. regeneration takes place only at time intervals), the system's full capacity is always shown.

Step nr:	6.2
Pulse period	100l

The impulse rate (k factor) of the water meter can be programmed for values of between 1 and 9999 litres per pulse/contact closure.

7. Flow-pulse (Standard Program).

Step nr:	7.1
Flow pulse	1,0s

For every impulse of the water meter the pulse relay K9 operates once. The contact duration can be programmed in the range of 0,2 to 999,9 seconds.

These output pulses can be used for

control of a dosing pump or a dosing monitoring system or to operate a remote flow rate measuring/control system.

If the interval between successive water meter pulses/contacts is less than the programmed output duration the impulses are stored by the control and the output relay reactivated the appropriate number of times. There is an interval of 0,5 sec between output pulses.

7. Flow-pulse (De alkalisation).

Step nr:	7.1
Refill time	20m

If the de alkalisation software option has been selected, Relay K9 is used to control the fill chemical fill valve of the chemical tank.

This valve operates for a pre-

programmed period of time when regeneration is initiated before the regeneration cycle commences. The refill time can be programmed for values between 5 and 60 minutes.

As soon as the chemical tank level system signals that the required volume of chemicals is present in the tank, by closing the "Chemical" input, the regeneration cycle will commence even if the pre-programmed time has not expired. If the "Chemicals" input is not operated before the pre-programmed time has expired an alarm condition results.

Step nr:	7.2
SV open	Y/N

It can be determined whether the operating valve of single filter systems is to be closed or open during the topping-up period.

IMPORTANT

The control is able to operate several different types of plant. If the "Hardness" key is held down when the power is switched on the control offers the choice of the "Standard" water softener/filter program or a "De- alkalisation" program, selectable by the "#"-key. If Standard "Y" is selected and the "#"-key is pressed again a "Motor valve" option is available (see page 27: Electrical control)

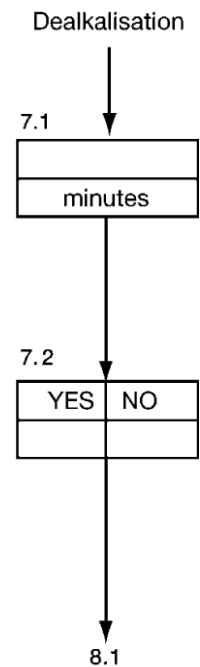
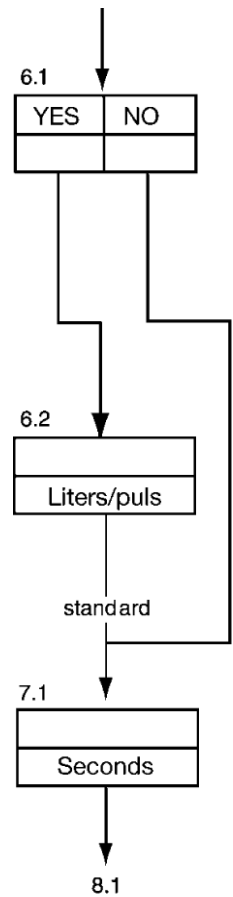



8. Incoming water supply hardness.

Any of the following units of measurement of water hardness can be used when operating the controller:

- °D = German water hardness
- °F = French water hardness
- °E = English water hardness
- mg/l = parts per million CaCO₃
- gpg = Grains per gallon

A conversion table for these units of water hardness is given below:

	°D	°F	°E	mg/l CaCO ₃	gpg	mmol/l
°D	1	1,78	1,25	17,85	1,04	0,18
°F	0,56	1	0,70	10,00	0,58	0,10
°E	0,80	1,43	1	14,30	0,83	0,14
mg/l CaCO ₃	0,056	0,10	0,07	1	0,058	0,01
gpg	0,96	1,71	1,2	17,1	1	0,17
mmol/l	5,60	10	7,02	100	5,82	1

IMPORTANT! The incoming water hardness is not entered as part of this basic program routine. Please see page 5 for details of how to program in the hardness.

Step nr: 8.1
Hardness [°D] Y/N

Step nr: 8.2
Hardness [°F] Y/N

Step nr: 8.3
Hardness [°E] Y/N

Step nr: 8.4
Hardness mg/l Y/N

Step nr: 8.5
Hardness [gpg] Y/N

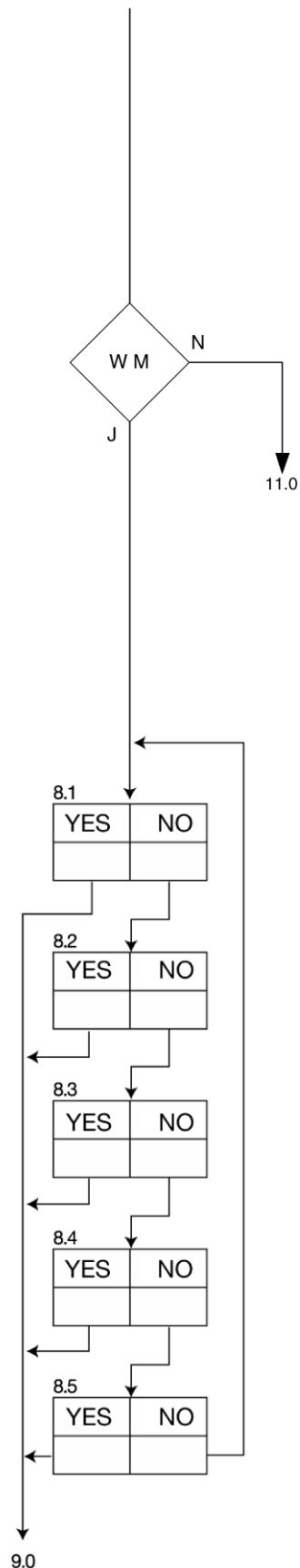



9. Exchange capacity.

Step nr:	9.0
Capacity	1800

The unit of exchange capacity is dependant on the unit chosen in step 8. It gives the amount of softened water in m³ as indicated in the chosen unit of hardness.

The amount of water which can be softened by each unit is automatically calculated as follows:

$$\frac{\text{Exchange capacity [mg CaCO}_3\text{]} \times 1000}{\text{Water hardness [mg/l CaCO}_3\text{]}} = \text{Softened water capacity [m}^3\text{]}$$

Example 1:

$$\frac{36000 \text{ mg CaCO}_3 \times 1000}{360 \text{ mg (/l CaCO}_3\text{)}} = 100 \text{ m}^3$$

or

Example 2:

$$\frac{2020 \text{ }^\circ\text{F m}^3}{40 \text{ }^\circ\text{F}} = 50,5 \text{ m}^3$$

The exchange capacity can be entered as a numeric value in the range of 10 and 655,350.

IMPORTANT Regardless of whether the installation is a simplex or duplex plant only enter the capacity of one exchange column.

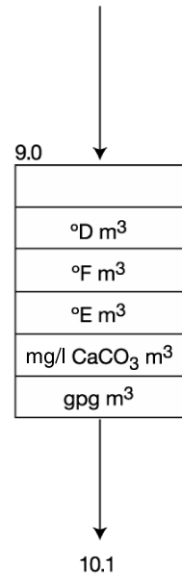

10. Pre regeneration signalling

Step nr:	10.1
Pre contact	Y/N

It is sometimes necessary to give a warning or to signal to another unit before the duty water softener is exhausted.

Step nr:	10.2
Capacity [%]	80

A limit value of anything between 1% and 99% of the operating capacity may be selected. For example, with a capacity of 180m³ between regeneration's and a selected limit of 80% the contact will be made at 144m³.

Step nr:	10.3
Reg.start	Y/N

This facility may be used to initiate regeneration of a simplex plant, and is used in conjunction with a prohibited regeneration period. (Section 3 above.) Regeneration will start at a fixed time, the end of the regeneration prohibited time, but only after a predetermined volume of water has been treated.

This allows a quantity of treated water to be held in reserve for use the following day. For example with a capacity of 180 m³ and pre contact at 80% there would be a treated water reserve capacity of 36 m³. When less than 36 m³ of treated water capacity remains a regeneration will take place when the next permitted regeneration time is reached.

IMPORTANT Untreated water must not be allowed to reach the user, it is important that there be sufficient reserve capacity to provide water during the time between the pre contact and the delayed regeneration cycle.

Step nr:	10.4
Alarm	Y/N

Step nr:	10.5
Warning	Y/N

If regeneration start has not been chosen, the message "PRECONTACT" appears in the LCD display. It is possible to operate the alarm or warning relays. It is therefore possible to initiate external preparations e.g. prepare the chemicals. Alternatively a water hardness monitor could be activated for the rest of the duty period.

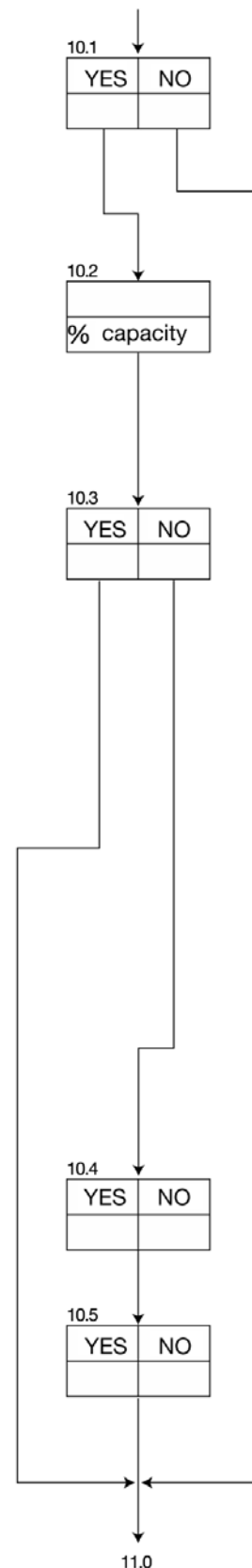



11. Number of valve switching pulses .

Step nr:	11.0
Stage	4

Remote control valves and pilot stagers are available with up to 9 steps. In this section of programming the number of control switch steps must be entered.

IMPORTANT Manufacturers often describe their product as a 5 stage valve with 4 switching stages when there is a change of function, usually in the chemical injection step, two different functions may then be achieved by one valve position i.e. injection and slow rinse.

Enter the number of switching steps required using the # (?) key.

12. Electrical control.

Remote control valves and stagers available in the market may be controlled in various ways, there are important differences: If the controller is programmed for a Fleck9000 (step 1.4 Yes) the electrical control will be automatically set at "Changeover"

- 1. Changeover switching
- 2. Pulse switching
- 3. Remote control
- 4. EURO control

IMPORTANT!

When valve systems operate at 24 V, current loading may be very high especially if the regeneration valve and several service valves are actuated simultaneously.

It is possible to switch on the motor(s) and valve(s) with a time delay of 30 seconds.

This time delay feature can be selected as follows:

1. Switch the power on to the controller while the "Hardness" - key is pressed. The display indicates "Standard" or "De-alkalisation" (See page 23).
2. Press the "#"-key twice, until the display indicates Motor valve Y/N.
3. Use the " " key to enter "Y" for the time delay and "N" for simultaneous switching of the motor(s) / valve(s).
4. Press the "Hardness" - key once again.

Changeover switching

With this type of control electrical power is switched from connections 5-6 to 5-7 on the main terminal strip as soon as the contact is made.

Step nr:	12.1
Changeover	Y/N

The following diagrams illustrate the operation of the various types of stager connected in this manner. The diagrams do not show the service condition which follows immediately after "regeneration end".

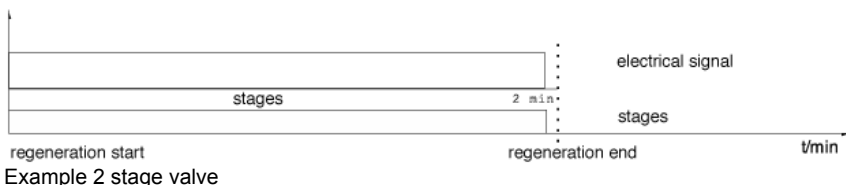

Example 2 stage valve

Remote Control.

With the remote control facility, the central control valve only requires a starting pulse on the connections 5-7 to perform the complete regeneration cycle. The times for the different regeneration steps are, generally speaking, catered for by the switching arrangements of the central control valve. The same times must also be entered in at step 14 of the programming

Step nr:	12.3
External	Y/N

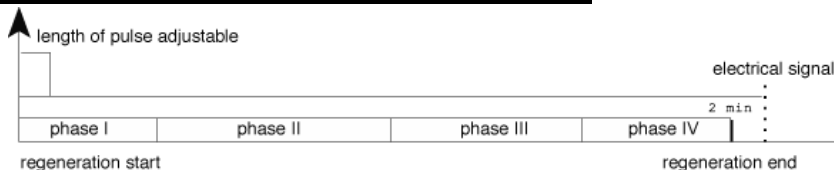

Example 5 stage valve with external signal

in order for the control to follow the regeneration cycle. An exact synchronisation of the central control valve and the indication on the display is however not possible

EURO Control

Step nr:	12.4
EURO	Y/N

The EURO valve is controlled by two electric valves. These are utilised to changeover the columns during regeneration initiation. The terminals are numbered 5,7 and 3,8. 12,4 and 3,15 respectively for the duplex column.

With duplex installations in exchange mode (Program step 1.2 = YES) it is possible to flush the standby stream before entering service.

Step nr:	12.5
Flush time	2m

This is achieved by opening a valve, connected across 3,8 and 3,15. The length of the flush can be programmed between 1 and 99 minutes. Should the step be programmed at value 0 (Zero) then no flush will occur.

Should the step be programmed at value 0 (Zero) then no flush will occur.

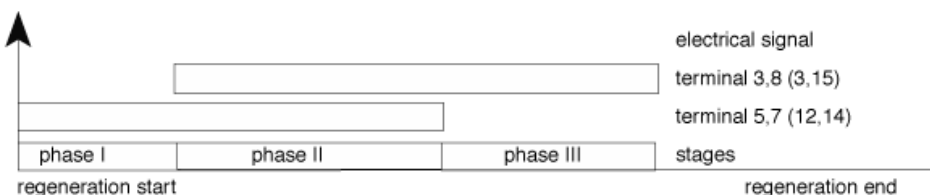

Example 4 stage EURO valve

13. Pulse timing.

If the pulse control in remote control mode is selected, the pulse time for each period must also be entered. Values in the range of 1 to 999 seconds can be programmed.

Step nr:	13.0
Pulse per. 1	50s

IMPORTANT. When using pulse control the pulse duration must not be longer than the shortest time step (see section 14, regeneration times).

IMPORTANT. Select the pulse to be programmed using the "#" key. Then use " " key to select the digit to be changed and use the "#" to change the value.

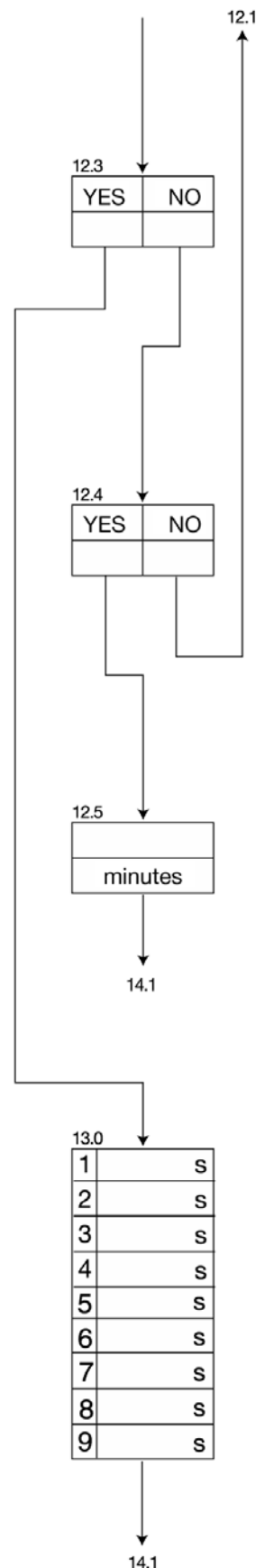



14. Regeneration times.

The duration of each stage of regeneration must be programmed. The number of stages was selected in programming section 11. No times need to be programmed for the "SERVICE" condition.

In this step the number and duration of the regeneration step must be entered.

Any value between 1 and 255 minutes can be programmed in.

Step nr:	14.1
Time phase 1	10m

For example for a 3 step regeneration.

Backwash Stage 1: 10 min.

Injection/slow rinse Stage 2: 60 min.

Fast rinse Stage 3: 15 min.

To adjust the step times, position the cursor to the step number using the "▶" key, select the required step using the "#" key then position to the figure to be changed using the "▶" key and alter the value using the "#" key.

To adjust another step time, reposition the cursor and proceed as above.

14.1

Regeneration times	
1	m
2	m
3	m
4	m
5	m
6	m
7	m
8	m

15.1



15. Additional programme (Regeneration-additional programme, Flushing, High pressure pump).

Step nr: 15.1

Outp. AD: AD | FL | HP

The output "AD" (Additional Programme) can be used for the following functions:

Either:-

1. **AD = An additional programme** during regeneration. This allows control of a valve or pump before, during or after a regeneration. It is possible to program the output to operate for a time period of between 1 and 999 minutes. (Programme step 15.2-15.4)

or:-

2. **FL=A timed flush signal** which can be used to open a dump valve flushing the plant to drain each time a pre-set volume of treated water has been produced. It is possible to programme duration's of between 1 and 255 seconds and volumes between successive flushes of between 1 and 65,000 litres (Programme step 15.5-15.6)

or:-

3. **HP=High pressure** pump allows control of a valve or pump during the regeneration or service. The initiation will be controlled by the input "WA".

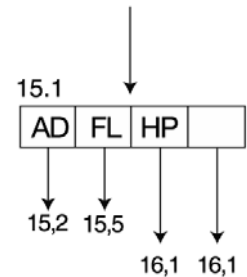

IMPORTANT

See programme step 17 (Input "Wait").

AD = Additional program during regeneration

Step nr:	15.2
Start phase:	2

It is possible to use the additional programme before the start of the actual regeneration, that means before the regeneration valve is initiated.

In this case program Start phase: 0

This function can also be used to flush out the stand by unit of a duplex

plant prior to bringing it into service.

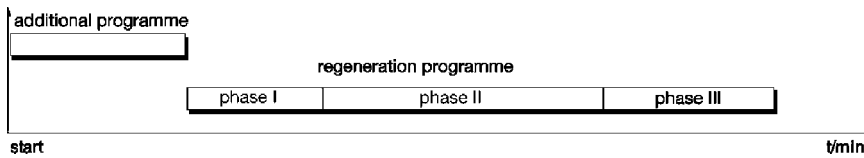
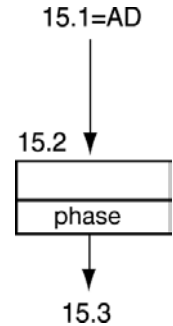

Example: additional programme before the actual regeneration

The additional program and a regeneration

cycle can also begin

simultaneously. The additional program can either be shorter, the same or of even longer duration than the regeneration program.

In this case program in the phase of regeneration which is to start simultaneously with the start of the additional program.

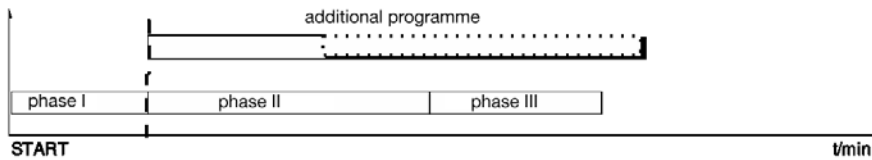

Example: additional programme starts with the second step of regeneration

The additional program can follow the regeneration cycle, so that, for

example, chemical tanks may be refilled, if required.

In this case program Start phase: E

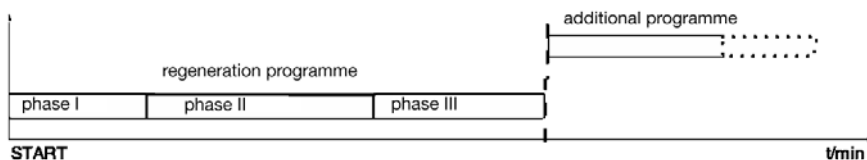

Example: additional programme follows the regeneration cycle

Regeneration-additional programme, Flushing

Step nr:	15.3
Time "ON"	40m

The duration of the additional program (Relay on / Relay off) can be programmed for between 1 and 999 minutes.

Step nr:	15.4
S.V.chng ovr	Y/N

If the additional program is active before the actual regeneration (“pre regeneration” and “flushing before service” are not programmed) then a decision has to be made :

For a simplex installation,
When should the outlet valve be closed? At the start of the additional program? (Change over"Y") Or as the additional program finishes, i.e. at the initiation of the regeneration cycle? (Change over "N")

For a duplex installation,
Operating in stand by mode should the stand by unit be brought on at the start of the additional programme (Change over "Y") or at the start of the regeneration of the exhausted unit (Change over "N")

ATTENTION : If the outlet valve is closed during the additional program before the actual regeneration, then the check for allowing regeneration will be made before starting the additional program otherwise this check will be made after the additional program.

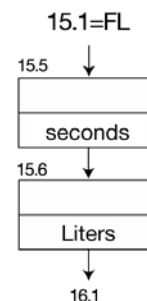
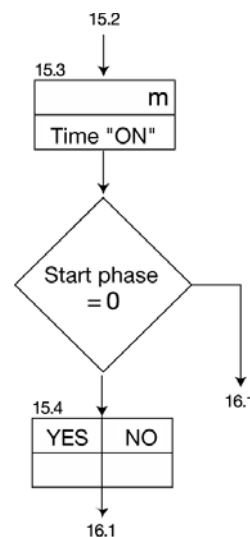

FL = Flush

Flush time

Step nr:	15.5
Flush time	20s

Calculate the flush time (range 0 to 255 seconds) IMPORTANT If "0" is entered, no flush will initiated.

Flush interval

Step nr:	15.6
Flush Interv.	500l

This is the setting for the amount of treated water to be supplied between flushes.

The permissible range is 1 to 65.000 litres.



16. Alarm and warning relay outputs.

During service and regeneration various signals are available which can be used to trigger either the alarm or warning relays. A comprehensive description of these signals is given earlier under the heading Alarms/warnings.

At step 5, at step 10 and at step 18 the relay outputs can also be sent signals. If a relay output is sent more than one signal, the relay operates as a joint fault / joint report.

If output relays are already occupied because of program choices made in section 5, 10 or 18 of the programming the relay will function as a collective alarm or warning relay.

Capacity exceeded.

Step nr:	16.1
Cap.exceeded	Y/N

Displays 16.1 - 16.4 only occur with 2-filter systems

Step nr:	16.2
Main valve on	Y/N

In step 16.2, the user has to decide, whether the outlet valve of the duty column is

Step nr:	16.3
Alarm	Y/N

to be closed as soon as the message "Cap. exceeded" appears, or is to remain open.

Step nr:	16.4
Warning	Y/N

Power supply failure.

Step nr:	16.5
Supply fail	Y/N

If power supply failure is a regular occurrence, operation of the alarm or

Step nr:	16.6
Alarm	Y/N

warning relay may be undesirable. If steps 16.5, 16.6 and 16.7 are answered YES, NO and NO

Step nr:	16.7
Warning	Y/N

respectively then only the supply failure message is shown. This should be reset at the earliest opportunity by pressing the "UNLOCK" key.

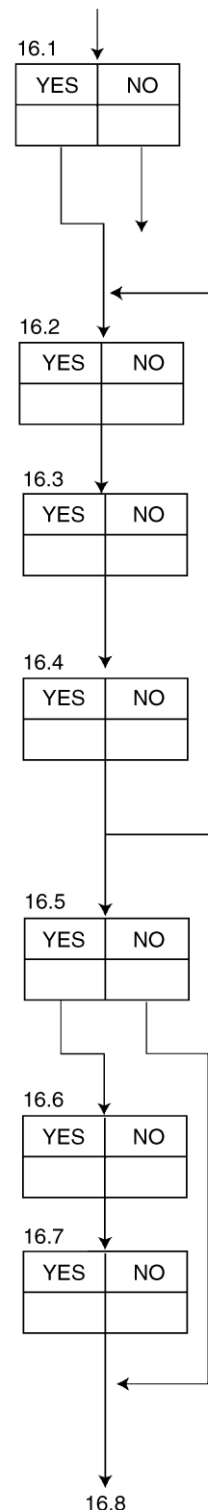

Refill chemical tank.

Step nr:	16.8
Reg.tank low	Y/N
Step nr:	16.9
OV open	Y/N
Step nr:	16.10
Alarm	Y/N
Step nr:	16.11
Warning	Y/N

It can be determined whether the operating valve of single filter systems is to be closed or open in the event of a fault.

Await regeneration.

Step nr:	16.12
Wait	Y/N
Step nr:	16.13
Alarm	Y/N
Step nr:	16.14
Warning	Y/N

17. Input "WAIT".

The Input "WAIT" can be active either during the regeneration cycle or during service.

Step nr:	17.1
Regener./Service	

During regeneration:
In duplex installations the stand by unit comes into service if the input is active during the start of

the regeneration. The initiation of the regeneration will be held off.

By pressing the "Start" button with the symbol , the signal can be overridden for the period of the regeneration.

By using the fast programme routine (see page 17) you can advance to the next programme step.

Application: regeneration inhibition

During service:

The service valves will be opened and, if in programme step 15.1 HP (pump) was selected, the output "AD" will operate.

Application: treated water storage tank level control.

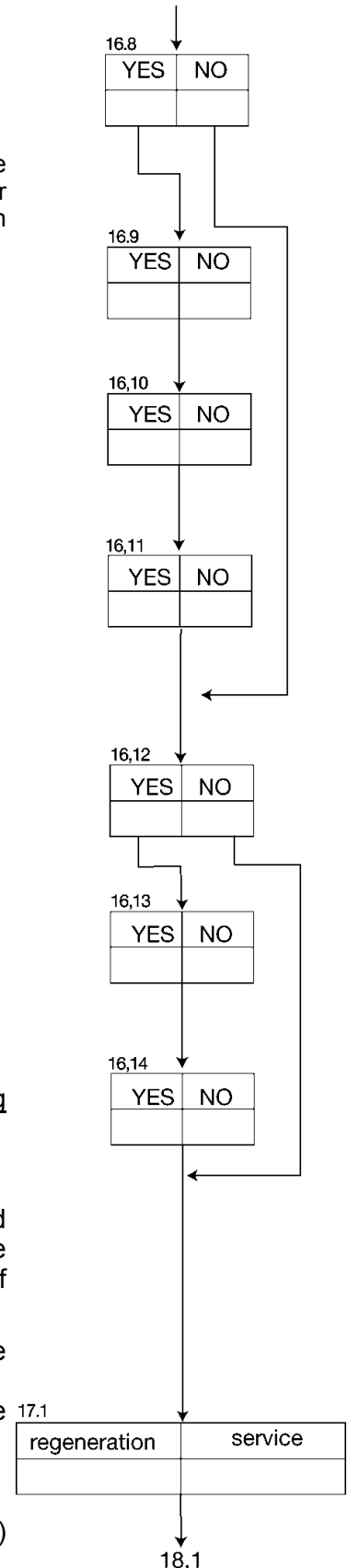



18. "Start" input

Regeneration delay 1

Step nr:	18.1
Reg. Delay 1	600s

This time setting (0-999 seconds) determines the number of seconds the "Start" input is blocked after a new regeneration

or a filter changeover, for instance to wait for a new analysis by a water hardness meter.

See page 15, "Start" input.

NOTE: If the controller has been programmed for de carbonisation, this time is a delay as in program step 18.2, but is activated only once after a regeneration or filter changeover, to allow the water quality to be tested immediately using e.g. a pH meter.

Regeneration interruption 2

Step nr:	18.2
Reg. Delay 2	10s

This time setting (0-999 seconds) determines a delay period for the "Start" input.

NOTE: If the "Wait" input is selected in program step 17.1 for

the service cycle the delay time is not reset until a service valve is open and the input is no longer active, i.e. no regeneration request if the operating valve is open.

19. Service

You can determine whether a "SERVICE REQUIRED" message is shown on the LCD display after a set supply quantity and whether the relay outputs "warning" and/or "fault" are activated when this message is displayed.

NOTE: This program step can only be called up by the appropriate service company.

Step nr:	19.1
Maintenance	Y/N

Step nr:	19.2
Interv.	50000m3

You can set a service interval from 1 to 650,000 m3.

Step nr:	19.3
Alarm	Y/N

The fault relay can be activated in addition to the LCD display.

Step nr:	19.4
Warning	Y/N

The report relay can be activated in addition to the LCD display.

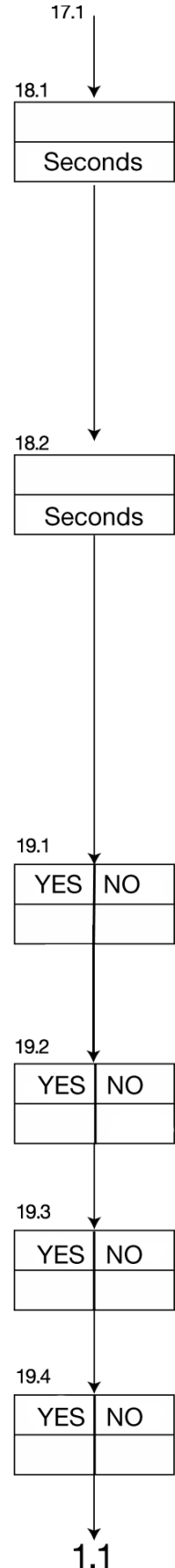

Typical installation diagram. Remote monitoring control.

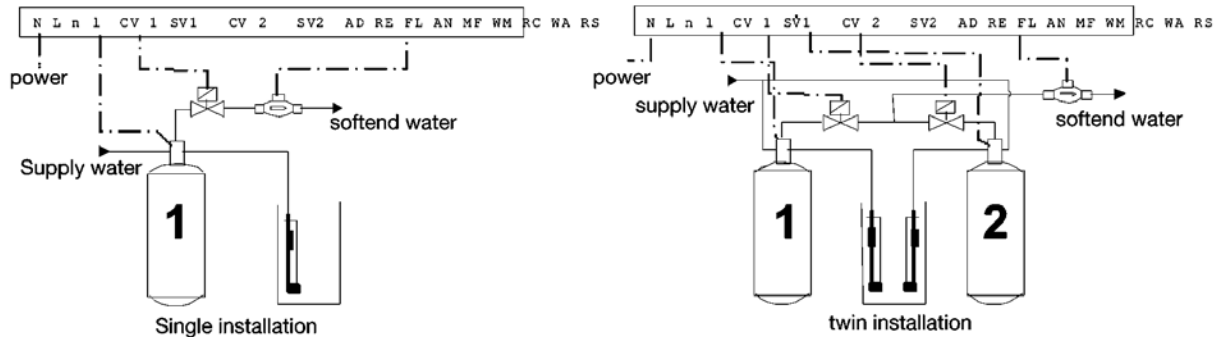

In order to permit remote monitoring of the water softening unit, a number of volt free relay contacts are available. Additional contacts can be obtained by wiring in of external relays.

The relay outputs **AN = Warning** and **MF = Alarm** can be used for any of the following signals:

1. Capacity exceeded.
2. Power supply failure.
3. Chemical tank low.
4. Await regeneration.
5. Minimum time between regeneration's.
6. Regeneration pre-contact.

The following relay outputs are also available.

- AD = Additional program routine (signal programmable during regeneration.)
- RE = Regeneration (regeneration taking place.)
- FL = Water flow (water meter pulse)

The following contacts could be repeated using an external relay.

- SV1 = Unit 1 outlet valve. (Unit 1 in service)
- SV2 = Unit 2 outlet valve. (Unit 2 in service)

Using two external relays and the output **RE = regeneration** it is possible to obtain signals as shown below:

Unit 1 in regeneration Unit 2 in regeneration

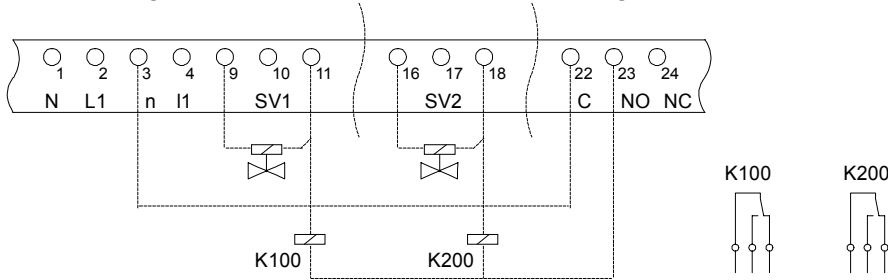

IMPORTANT The external relay contacts should not be used to provide both volt free signals for monitoring and powered signals for control, use additional relays.



Typical Electrical wiring diagrams.

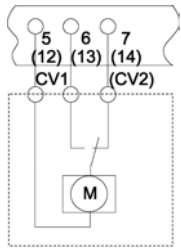

Remote control valves or pilot stagers which do not automatically return to the service position.

Two or four steps.

Changeover switch control of positioning.

The live output is switched between terminals 6(13) and 7(14)

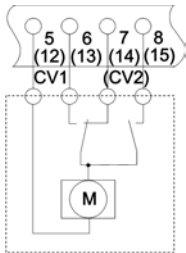

Remote control valves or pilot stagers which automatically return to the service condition.

Two or four steps.

Changeover switch control of positioning.

The live output is switched between terminals 6(13) and 7(14). In the service condition terminal 8(15) is live.

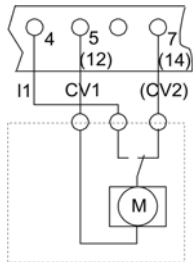

Remote control valves or pilot stagers which do not automatically return to the service position.

Two, four or five steps.

Pulse switch control of positioning.

Valve with integral program routine (external control).

Pulsed live output at terminal 7(14).

Maintained drive supply from terminal 4.

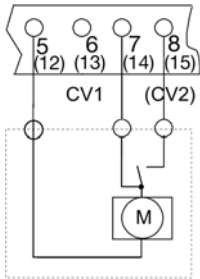

Remote control valves or pilot stagers which automatically return to the service position.

Two, four or five steps.

Pulse control of positioning.

Pulsed live output at terminal 7(14).

In the service condition terminal 8(15) is live.

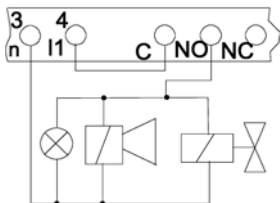

Connection of **signal lamp, klaxon or solenoid valve** using the volt free relay outputs AD, RE, FL or AN.

I1 and C to be bridged.

Warning Do not connect the alarm relay output (MF) in this manner.

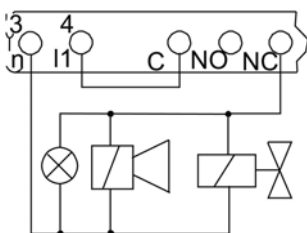

Connection of **signal lamp, klaxon or solenoid valve** using the volt free alarm relay output (MF).

I1 and C to be bridged.

Normally open Solenoid valves should be connected to the NC terminal instead of the NO terminal.

IMPORTANT The alarm relay output (MF) uses the normally closed contact (NC) instead of the normally open contact (NO).

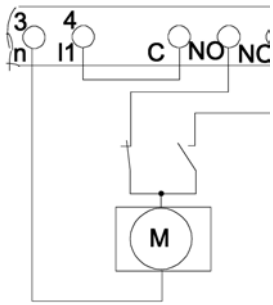

Local **motor isolators** may be required connected to the relay output.

I1 and C to be bridged.

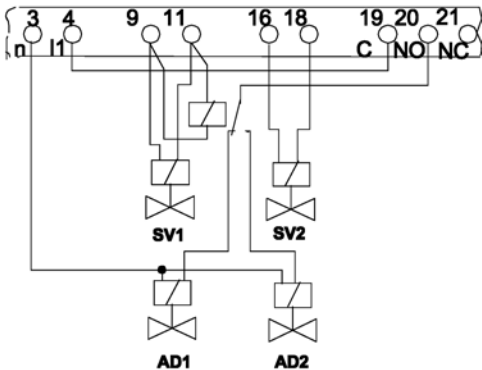

Splitting of the additional program output with connections for two additional isolating valves AD1 and AD2.

With the help of two extra relays it is possible to connect the output of the additional program to two unit dependant isolation valves if required.

Relay outputs RE and FL may be treated similarly.

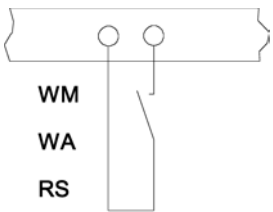

Inputs:

- WM = water meter
- WA = wait
- RS = regeneration start

These inputs are activated by closed a volt free contact.

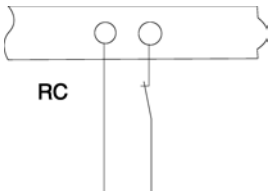

Input:

RC= regeneration chemicals

This input is activated by an open volt free contact.

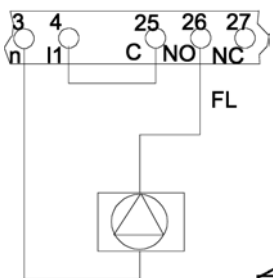

Connection of a dosing pump:

A dosing pump, of the correct voltage may be connected directly across terminals 3 and 26.

Terminals 4 and 25 must be linked.

The pulse duration must be set (section 7 of the programming notes).

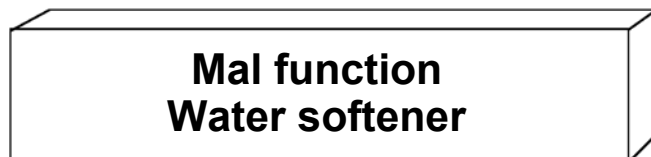

Connections to remote displays and computer systems may be accommodated on request.



Electrical connection details ES 2050 and ES 2051

- ES 2050 24 Volt: only earth terminal 46, no control lamp in the main switch
- ES 2051 115 and 230 Volt: only protective earth terminal 46
- ES 2051 24 Volt: only earth terminal 46
- ES 2051: all executions without main switches

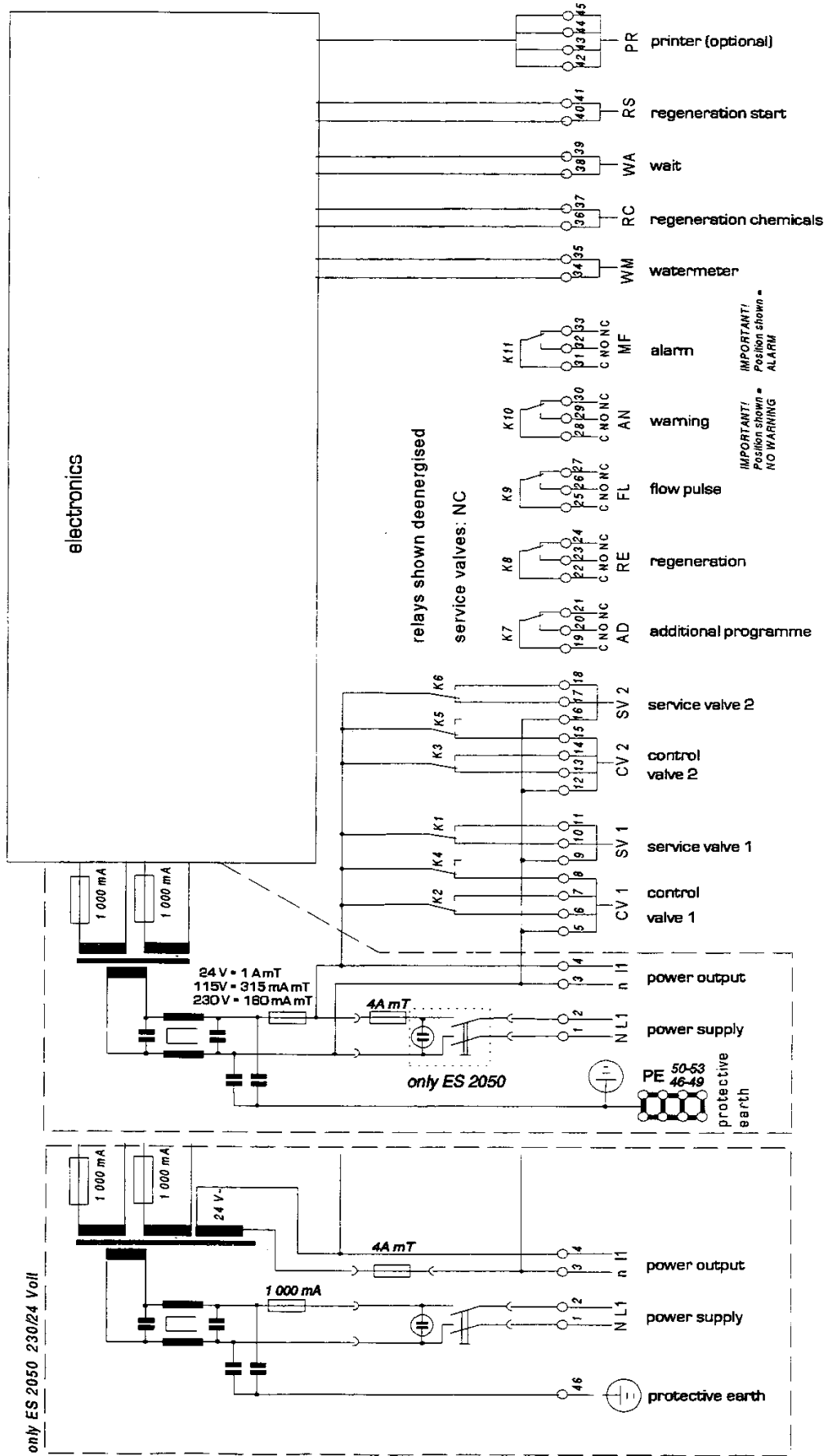



Installation recommendations and commissioning

Mount the control at eye level in a convenient place for the user.

Do not mount under pipe work if there is risk of condensation. Apply protection and screening as necessary.

Panel mounted units should be fitted into a prepared panel opening of 186 x 138 and fixed using the brackets provided.

Make the electrical connections. Take note of all applicable regulations.

Take special care to ensure a good earth connection.

Low voltages cables (terminal nos.. 34 to 41 i.e. connections: WM, RC, WA and RS) should be segregated from supply cables carrying high voltage.

IMPORTANT The panel is supplied without a mains isolating switch. This should be provided as part of the installation.

IMPORTANT The front plate of the panel is provided with a plug link to the earth connection ensure that this is not disconnected during commissioned and installation.

Switch the equipment on and follow these instructions and the technical information supplied by the equipment manufacturer to program the controller. Do not forget to set the supply water hardness and the current time.

Install all equipment in accordance with the manufacturers instructions. Take special note of the type of regeneration control requirements and the quality of the incoming water supply.

IMPORTANT The front panel should always be kept closed.

Technical specifications



Electrical supply:	230 V ± 10% 50-60 Hz fuse 4 A mT 115 V ± 10% 50-60 Hz fuse 4 A mT 24 V ± 10% 50-60 Hz fuse 4 A mT 230/24 ± 10% 50-60 Hz fuse 4 A mT
Power consumption control circuit:	11 VA
Powered outputs:	Up to a maximum total load of 4A
Potential free outputs:	Maximum load on relay contacts 250V / 4A
Potential free inputs:	Contacts loaded up to a max. 9V / 8mA
Protection class:	IP 65 (ES 2050) IP 42 (ES 2051)
Ambient temperature:	0 - 50 C
Weight:	approximately 2.8 kg
Dimensions	
Type ES 2050 (wall mounted):	W x H x D = 263 x 216 x 142
Dimensions	
Type ES 2051 (panel mounted):	DIN 43 700 front 192 x 144 mounting depth 122 panel opening 186 x 138 ^{+1,0}

Equipment is protected against zero voltage.
Reset the current time when there has been a power failure.

Declaration of conformity

Declaration of conformity of the product with the essential requirement of the EMC directive 89 / 336 / EEC.

Product description

Product name : Controller for water softening installations
Product type : ES2050, ES2051
Manufacturer : EWS Equipment for Water treatment Systems International B.V.

Product environment

This product is intended for use in residential en light industrial environments.

Emission standard : EN 55022, class B
Immunity standard : EN 50082-1

Report

Report number : EWS / EMC / 9506

This declaration was issued by :

Date : 06 - 12 - 1995

Name : D.H. Naeber

Signature :

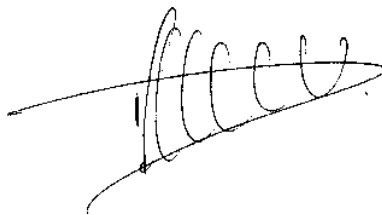
A handwritten signature in black ink, consisting of a series of loops and a long horizontal stroke, positioned to the right of the 'Signature' label.